

GRILL STATIONS



Roband Grill Stations

The modern, stylish Roband Grill Station is available in six or eight slice size models.

The Roband range sets the benchmark for commercial contact grills. The versatile unit rapidly toasts sandwiches, paninis and focaccias, in addition to producing beautifully seared and grilled tender meat, poultry and fish. Featuring elements embedded directly into smooth, precision cast aluminium plates, the cooking surface produces an even, extremely efficient heat transfer ensuring food is cooked rapidly with even colouration.



Pictured:
Top - GSA810SE 8 slice with electronic timer
Bottom - GSA610R 6 slice with ribbed top plate

Roband Grill Stations are now available with manual or electronic timers. The manual timer provides an audible ding after the set time (each number on the timer represents the amount of minutes it will count down). The electronically timed models have 4 individual timers, each with their own individually adjustable pre-set time periods (up to 10 minutes). The electronic timers provide an audible buzz after the pre-set time elapses.

The Roband Grill Station truly is a must-have for cafés, restaurants, takeaways, sandwich shops or anywhere that toasting and / or grilling is required.

Made in Australia - Built to Last!

Roband Grill Stations with Manual or Electronic Timers



GSA610S pictured

Grill Stations



Features

- Six or eight sandwich capacity
 - Quality high pressure die-cast aluminium cooking plates with cast-in elements for efficient, directional and effective heat transfer
 - Precise thermostat for controlling cooking temperature
 - Even temperature distribution across each plate and between the top and bottom plates
 - Ability to switch between top and bottom plate operation or bottom plate only operation
 - A counter-balanced top plate and an arched handle makes operating the Grill Station easy
 - Easy one-handed loading and unloading of food while the top plate stays open half way
 - Food quality and appearance is protected from over compression by the counter balanced and self levelling top plate
 - High splash guard with top plate always positioned over bottom plate ensuring grease and crumbs fall onto bottom plate
 - Small counter space requirement due to the elimination of a cumbersome back cable
 - A front positioned grease collection box collects grease and crumbs and is well-positioned for easy removal and cleaning
 - Angled control panel for clear visibility of settings
 - 5 minute Manual Timer with warning bell
 - Electronic Timer models with 4 individually adjustable pre-set times available (up to 10 minutes)
 - Includes one premium Spatula
- Optional accessories:
- Ribbed top plate and / or non-stick coating (Not available for the Electronic timer models)
 - Non-stick Roband Grill Sheet & Retainer Clip keeps the plates clean, prevents food sticking and is removable, cleanable & replaceable
 - Plate spacers are available separately for very thin contents
 - Side draining grease channel for high volume waste (model GC6 or GC8) (Not available for the Electronic timer models)



The Range



Electronic Timer models with 4 individually adjustable pre-set times available (up to 10 minutes)



GSA610S
6 slice, smooth plates



GSA610R
6 slice, ribbed top plate



GSA610SE
6 slice, smooth plates



GSA810S / GSA815S
8 slice, smooth plates



GSA810R / GSA815R
8 slice, ribbed top plate



GSA810SE / GSA815SE
8 slice, smooth plates

Non-stick options



Teflon® Non-stick coated plates
shown on GSA815ST



Roband Grill Sheet with clip shown
on GSA610S - (PGS605 & RC6)

Manual timer models are available with non-stick coated plates. All models are available with the optional Roband Grill Sheet and Clip.

Specifications

MODEL	SLICES No.	TIMER	PLATE COATING	TOP PLATE	POWER Watts	CURRENT Amps	DIMENSIONS w x d x h (mm)	BOTTOM PLATE DIMENSIONS w x d (mm)
GSA610S	6	MANUAL	NIL	SMOOTH	2200	9.6	435 x 490 x 228	375 x 275
GSA610R	6	MANUAL	NIL	RIBBED	2200	9.6	435 x 490 x 228	375 x 275
GSA610ST	6	MANUAL	NON-STICK	SMOOTH	2200	9.6	435 x 490 x 228	375 x 275
GSA610RT	6	MANUAL	NON-STICK	RIBBED	2200	9.6	435 x 490 x 228	375 x 275
GSA610SE	6	ELECTRONIC	NIL	SMOOTH	2200	9.6	435 x 490 x 248	375 x 275
GSA810S	8	MANUAL	NIL	SMOOTH	2300	10.0	560 x 490 x 228	500 x 275
GSA810R	8	MANUAL	NIL	RIBBED	2300	10.0	560 x 490 x 228	500 x 275
GSA810ST	8	MANUAL	NON-STICK	SMOOTH	2300	10.0	560 x 490 x 228	500 x 275
GSA810RT	8	MANUAL	NON-STICK	RIBBED	2300	10.0	560 x 490 x 228	500 x 275
GSA810SE	8	ELECTRONIC	NIL	SMOOTH	2300	10.0	560 x 490 x 248	500 x 275
GSA815S	8	MANUAL	NIL	SMOOTH	2990	13.0	560 x 490 x 228	500 x 275
GSA815R	8	MANUAL	NIL	RIBBED	2990	13.0	560 x 490 x 228	500 x 275
GSA815ST	8	MANUAL	NON-STICK	SMOOTH	2990	13.0	560 x 490 x 228	500 x 275
GSA815RT	8	MANUAL	NON-STICK	RIBBED	2990	13.0	560 x 490 x 228	500 x 275
GSA815SE	8	ELECTRONIC	NIL	SMOOTH	2990	13.0	560 x 490 x 248	500 x 275

Note: All bottom plates are smooth. Timer does not over-ride or control thermostat.

Grill Station Accessories Description

- Retainer Clip & Grill Sheet - these are used to keep the Grill Station plates clean during use. They are easily removed for washing. The sheet is also non-stick preventing the food from sticking to the plates. Ideal for high productivity and fast cleaning.
- Side Draining Grease Channel - this is designed to handle high volume of grease from cooked food. The Grease Channel drains into a collection vessel such as a small steam table pan. Not available for the Electronic Timer models.
- Rear Stand - the Rear Stand is designed to raise the Grill Station rear so that grease and crumbs drain and collect in the forward positioned grease box.
- Plate Spacer - various sizes are available and these are designed to ensure a consistent height is maintained between the top and bottom plates during operation. These are ideally suited to preparation of delicate products such as croissants.
- Aluminium Grill Pattern Plates - Designed to sit between the Grill Station smooth plates and Grill Sheet with Clip, the Aluminium Grill Pattern Plates produce a crosshatched char grill style pattern on the food being produced.

Accessories

SUITS GRILL STATION MODELS	SHEET RETAINER CLIP MODEL NUMBER	ROBAND GRILL SHEET (PTFE) (NON-STICK) MODEL NUMBER	SIDE DRAINING GREASE CHANNEL*	PREMIUM SPATULA (ADDITIONAL)
GSA610 GSA610SE	RC6	PGS605 (5 pack QTY) PGS610 (10 pack QTY)	GC6	SP12 (12 pack)
GSA810 & GSA815 GSA810SE & GSA815SE	RC8	PGS805 (5 pack QTY) PGS810 (10 pack QTY)	GC8	SP12 (12 pack)

* Not available for the Electronic timer models

Dimensions

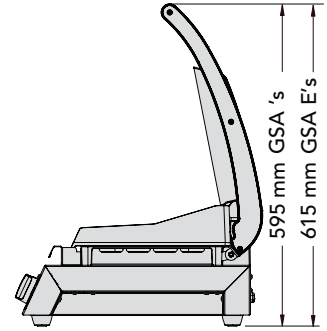
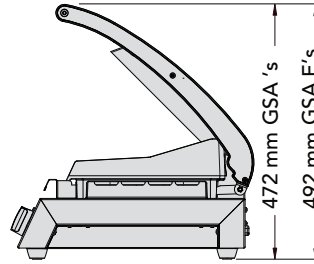
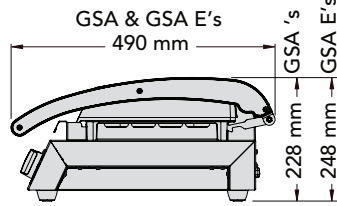
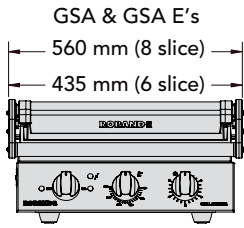

Optional removable Grill Sheet with Retainer Clip

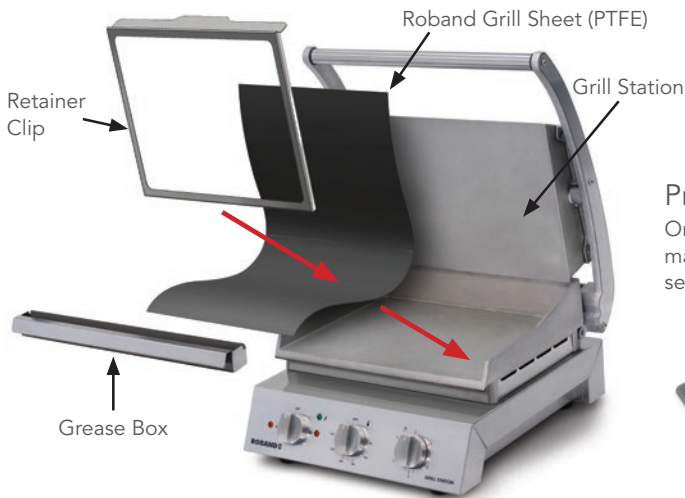

Premium Spatula

One is included with each machine. Also available separately.



Side Draining Grease Channel

Not available for Electronic timer models



Pan not included

Spacers available in various sizes to suit

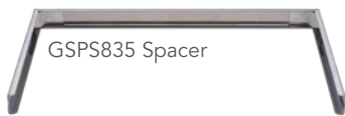

GSPS835 Spacer

GSPS835 Spacer inside a GSA810S

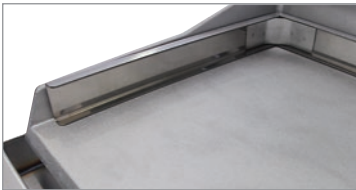

Rear Stand

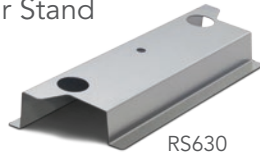

RS630

GSA810S sitting on a rear stand RS830



Aluminium Grill Pattern Plate

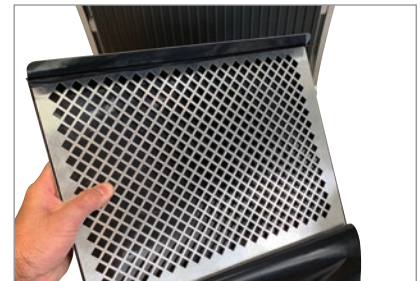

Showing easy installation on a Grill Station top plate



Showing easy installation on a Grill Station bottom plate



REAR STAND

RS630

RS830

PLATE SPACER

GSPS625
GSPS635
GSPS645

GSPS825
GSPS835
GSPS845

ALUMINIUM GRILL PATTERN PLATE

GS6-P1
(a set of 2)

GS8-P1
(a set of 2)



Roband Grill Stations are manufactured in Australia by Roband Australia Pty Ltd.

All standard Roband Grill Stations are designed to run at 230V single phase, 50Hz.

All dimensions are nominal only. All information contained in this brochure should serve as a guide only and is subject to change without notice due to constant research and development.

© 2021 Roband Australia Pty. Ltd. ACN 003 049 063 ABN 34 864 327 105

® is a registered trademark of Roband Australia Pty. Ltd.

Distributor: